

The BOLD Response to Interictal Epileptiform Discharges

**Christian-G. Bénar, Donald W. Gross*, Yunhua Wang, Valentina Petre, Bruce Pike,
François Dubeau, Jean Gotman**

Montreal Neurological Institute,
McGill University, Montréal, Québec, Canada

Running title : BOLD response to EEG spikes

Corresponding author:

Jean Gotman, PhD

Montreal Neurological Institute

3801 University Street

Montreal, Quebec, Canada, H3A 2B4

Tel: +1 514 398 1953

Fax: + 1 514 398 8106

jgotma@mni.mcgill.ca

* current address: University of Alberta, Edmonton, Alberta, Canada

ABSTRACT

We studied single-event and average BOLD responses to EEG Interictal Epileptic Discharges (IEDs) in four patients with focal epilepsy, using continuous EEG-fMRI during 80 minute sessions. The detection of activated areas was performed by comparing the BOLD signal at each voxel to a model of the expected signal. Since little is known about the BOLD response to IEDs, we modeled it with the response to brief auditory events (Glover 1999). For each activated area, we then obtained the time course of the BOLD signal for the complete session and computed the actual average hemodynamic response (HR) to IEDs.

In two patients, we observed clear BOLD responses to single IEDs. The average response was composed of a positive lobe peaking between 6s and 7s in all patients and a negative undershoot in three patients. There were important variations in amplitude and shape between average HRs across patients. The average HR presented a wider positive lobe than the Glover model in three patients and a longer undershoot in two. There was a remarkable similarity in the shape of the HR across areas for patients presenting multiple activation sites. There was also a tendency towards a linear correlation between the amplitude of individual BOLD responses and the amplitude of the corresponding EEG spike.

The possibility of a longer HR and the predictability of its amplitude could be used to improve statistical detection of activation in simultaneous EEG-fMRI. The variability in average HRs across patients could reflect in part different pathophysiological mechanisms.

Keywords: simultaneous EEG-fMRI, interictal epileptic discharges, BOLD, hemodynamic response

INTRODUCTION

Interictal epileptiform discharges (IEDs) are studied routinely in the evaluation of patients with epilepsy. The classical technique used is electroencephalography (EEG), on which IEDs produce marked and stereotyped deviations of the traces. Recently, the recording of EEG in the magnetic resonance (MR) scanner (Ives et al. 1993, Huang-Ellinger et al. 1995) has enabled the study of electrographic events with functional MR imaging (fMRI), making use of the Blood Oxygen Level Dependent (BOLD) effect (Kwong et al. 1992, Ogawa et al. 1992). This is a challenging task because of the artifacts caused by the changing magnetic field on the EEG and by the EEG equipment on MR images. It is, however, an exciting possibility because it may allow accurate anatomical localization of the generator of IEDs by correlating changes in BOLD signal and the presence of IEDs recorded with surface EEG. It may also provide information on the mechanisms underlying IEDs, since the metabolic change measured by fMRI is a consequence of the abnormal neuronal activity generating the IED (Buxton et al. 1998, Hoge et al. 1999). Images can be acquired either immediately after each event ('EEG-triggered fMRI', Warach et al. 1996, Seeck et al. 1998, Allen et al. 1998) or continuously ('continuous EEG-fMRI', Lemieux et al. 2001, Baudewig et al. 2001). The temporal characteristics of the BOLD response to IEDs constitute a very important aspect of this technique. Indeed, the statistical detection of brain activation relies on assumptions about this signal that have not yet been verified. Also, it may be of physiological interest to understand better the determinants of the magnitude of the BOLD response.

We propose to study in a group of selected patients the relationships between IEDs and the BOLD signal, using continuous EEG-fMRI.

MATERIALS AND METHODS

Recording: We recorded within a 1.5T MR scanner (Siemens Vision, Siemens, Erlangen, Germany) 21 channels of EEG on patients presenting focal epileptiform discharges during their clinical scalp EEG evaluation. EEG recordings were made with an EMR32 amplifier (Schwarzer, Munich, Germany). We acquired 7 to 10 runs of 120 frames, each frame consisting of 25 BOLD 64*64 images, with a TR of 50ms, a voxel size of 5x5x5mm, and a repetition time of 3s. Each run therefore lasted approximately 6 minutes. Given the one to two minute inter-run gap, the complete session lasted up to 80 minutes.

EEG analysis: The EEG was processed offline in order to filter out the scanner artifact (FEMR software, Schwarzer, Hoffmann et al. 2000). Although there was also some ballistocardiogram artifact, we found that it was sufficiently low to allow identification of epileptic spikes and we did not use any special procedure to remove it. The filtered EEG signal was reviewed by experts who marked the time of epileptiform discharges.

Image analysis: We performed statistical processing of the images using the methods of Worsley et al. (1996) in order to find the areas that were activated in response to the IEDs. A model of the expected BOLD response to the IEDs was created based on the timing of the epileptic discharges and a model of the hemodynamic response (HR) to brief auditory events (Glover 1999). Images were motion corrected and smoothed with a gaussian filter (6mm FWHM). We obtained statistical maps of activation indicating at each voxel the level of correlation between the BOLD signal and the model (t-stat maps). Slow fluctuations in the MRI signal were taken into account by including a third order polynomial in the linear regression. We computed for each patient the significance level for an average brain volume (1200cc), which depends on the total number of frames per patient (Worsley et al. 1996). The resulting values ranged between 4.41 and 4.44. We used 4.4 as a threshold on the t-stat maps. We defined regions of interest (ROI) as clusters of contiguous voxels with a t-stat score above the threshold.

BOLD time course: We obtained for each ROI the time course of the BOLD signal during each run by averaging the signals of all the voxels within the ROI. This resulted in 7 to 10 120-sample BOLD time courses for each ROI.

Individual and mean hemodynamic response: In order to estimate the hemodynamic response (HR) to IEDs with a good signal to noise ratio, we needed to average the BOLD signal following several IEDs. To avoid contamination by neighboring IEDs, we averaged only the response to *isolated* IEDs, defined as spikes or bursts of spikes with no other epileptiform activity in a window around the event. This window spanned 30s preceding and 30s following the event, except in patient C where this constraint resulted in a very poor signal to noise ratio. Reducing this constraint to 15s increased the number of IEDs that could be averaged and resulted in a better signal to noise ratio, at the expense of the length of the averaging window. Prior to averaging, we fitted a third order polynomial to every run of BOLD signal and subtracted it from the data to remove slow fluctuations, thus emulating the polynomial used during statistical processing.

In order to average the individual responses, we had to define for each the point corresponding to $t=0$ s. As IEDs occur at a random time within the 3s image frame, it is important to take into account this variability to average points that correspond to the same part of the HR. The method is described in figure 1. The timing of each BOLD sample was taken as the time of the slice containing the maximum score in the ROI (the 25 slices are taken sequentially, with 110ms between two slices). BOLD signals were then interpolated to obtain one value every second. For each individual BOLD response, the time origin for averaging was taken as the point in the oversampled signal that was closest to the corresponding IED (Fig. 1).

Correlation IED/BOLD response: We attempted to determine if there was a relationship between the amplitude of the EEG during the IED and the amplitude of the corresponding BOLD response. The amplitudes of isolated IEDs and single BOLD activations were measured as the square root of the energy of these signals in the time range of the event. For IEDs this included the spike and the following slow wave. For the BOLD response, this included only the first positive lobe. Isolated IEDs were defined as events without another IED 30s before or 30s after. We compared the amplitude of each BOLD response either to the amplitude of the corresponding single EEG spike or to the sum of amplitudes of all the spikes in the burst when applicable.

Correlation between BOLD responses in different regions: As patients B and D presented several distinct areas of activation, we measured the correlation in the time course of the BOLD signal between pairs of ROIs as a function of time. We used a running correlation of 10 samples (i.e. 30s) with overlapping windows.

Subjects: Patients were selected on the basis of having focal and frequent interictal spiking; their informed consent was obtained in accordance with regulations of the Research Ethics Board of the Montreal Neurological Institute and Hospital. We included in this study only the small subgroup of patients with clear fMRI activations (i.e. statistically significant clusters of activated voxels) that were spatially consistent with EEG findings.

RESULTS

Table 1 presents a summary of EEG and fMRI findings for the four patients in the study. Typical IEDs are shown for each patient on Figure 2. In all four cases, artifact filtering introduced only minor distortion in the waveforms, which were quite similar in temporal shape

and spatial distribution to the waveforms outside the scanning period (including the atypical waveform of patient D). Figure 3 illustrates the activated areas for each patient. All but one (third ROI of patient D) are within a few centimeters of the EEG electrodes with maximum signal amplitude. The size of the ROIs for patients A,B and C ranged between 20 and 58 voxels, which corresponds to volumes between 2.5 and 7.25 cm³. Patient D had only 1 or 2 voxels above the threshold in each of the three ROIs. It is important to remember that this threshold was determined for *individual* voxel activation, which is a demanding definition. If one considers clusters of contiguous voxels, the threshold can be lowered and still produce significant regions - defined as *groups* of voxels (Worsley et al. 1996). We verified that lowering the threshold to 2 for patient D lead to clusters of voxels that were significant as a group.

Bold time course: Figure 4 illustrates the BOLD time course of one representative 6-minute run for each patient. For patients A and B, every IED (marked by arrows) was followed by a clear increase of the BOLD signal, lasting several samples. Single responses were more difficult to see for patients C and D. In some cases, series of consecutive IEDs were followed by a larger response than individual ones (e.g. around frame 75 for patient C and around frame 30 for patient D), but this was not always the case (e.g. before frame 40 in patient C). We noted the presence of a few BOLD events that resembled the BOLD increase following an IED but did not correspond to any visible scalp epileptiform EEG activity (Fig. 4b). We also observed large slow fluctuations with an amplitude of up to 1% in the course of a run, and a period of up to 100s (e.g. Fig. 4a).

Average hemodynamic response: Table 1 shows the number of IEDs that were used to obtain the average hemodynamic response for each patient, given the constraint that IEDs are *isolated*. The average HRs were relatively similar to the model of Glover: they all had a positive lobe that peaks between 6 and 7 seconds after the IED, and three presented a negative response (undershoot) following the main lobe (Fig. 5). There were notable differences though: patients A,B and D had a wider main lobe, patients B and D had a longer and more pronounced undershoot than the model - especially patient D whose response lasted up to 45s. There was no undershoot at all in patient A. In patient C, the standard deviation is particularly high. The morphology of the response in patient C is relatively Across patients, the maximum signal change varied significantly, ranging from 0.4% to 1.5% (relative to baseline, defined as the value

of the third order polynomial that models slow fluctuations). For patients with several areas of activation, the average HRs were remarkably similar between ROIs (Fig 5b and 5d).

Correlation IED/BOLD response: The time range and channel in which the signal energy was computed is shown on the traces on figure 2. The magnitude of individual BOLD responses did not seem correlated with the EEG spike magnitudes for patient B, whereas there is an indication of a linear relationship in patients A, C and D (Fig. 6)- even though no correlation was significant at a 95% significance level.

Correlation between BOLD signals in different regions: The running correlation between the BOLD signals of the two ROIs of patient B shows that their activity is in general correlated around the timing of IEDs and not elsewhere (fig. 7). There are some notable exceptions though, where the correlation is high with no visible activity on the scalp or, on the contrary, when there is a low correlation even at the time of IEDs. For some events there is a BOLD response in the posterior temporal lobe and not in the anterior part, but not the reverse. The results of patient D are more difficult to interpret due to the high density of events but have the same tendency (i.e. high correlation around IEDs and not elsewhere).

DISCUSSION

We recorded simultaneously and continuously the EEG and BOLD activity in patients with focal epilepsy. In the subset of patients in whom we found brain regions that were significantly activated in relation to epileptic activity, we examined the time course of the BOLD signal throughout the experiment. In two of four patients, we observed a clear BOLD signal increase following most individual IEDs and little activity away from IEDs. Considering that the active regions are compatible with the EEG field and that the amplitude of the BOLD signal increase is in the expected range for cortical venules (Ogawa et al. 1998), we feel reasonably confident that this represents a true response to the epileptic events. In the other two patients, we encountered a less convincing increase in BOLD signal following individual IEDs, and a larger amount of activity outside of events. Nevertheless, the high statistical score on the whole data set and the compatibility with EEG suggests again that this is a true albeit small response. The increase in BOLD activity away from IEDs could be related to epileptic activity that is not apparent on the scalp, or to normal brain fluctuations that are similar to the small epileptic responses.

We observed the typical slow fluctuations in the BOLD signal, but these were not always modeled correctly by the third order polynomial used in our analysis. This is a sensitive point because of the scarcity of the events and the low signal amplitude in some cases. This would call for a more advanced preprocessing in order to improve statistical detection, such as high pass filtering (Kruggel et al. 1999). Also, the fact that slow fluctuations are of the same order of magnitude as the signal could pose problems to spike-triggered methods that consider samples widely spaced in time and cannot easily take into account such baseline fluctuations.

There was a high variability in the amplitude of individual BOLD responses within patients. The amplitude of the BOLD signal had a tendency to be correlated with the EEG amplitude for patients that have mostly isolated spikes. The correlation could be explained by the fact that the number of neurons that are taking part in the excessive epileptic discharge in part determines the amplitude of the EEG. Presumably this same number of neurons will determine the magnitude of the metabolic response. The patient that shows the lowest correlation (patient B) is also the one that has mainly long bursts and the two patients that have the higher number of spikes (C and D) are the ones with smaller HR amplitudes, suggesting different mechanisms in the metabolic demand for different types of epileptic activity.

The overall shape of the average HR was consistent with the one obtained in classical event-related fMRI experiments, and with the one reported for one patient by Lemieux et al. (2001). This was expected because the detection method we used implies that the response is similar to the model, but there is still some latitude for shape changes. Indeed, the HRs we observed are wider than the model and two patients present long undershoots. Patient C shows some late activity, but one has to remember that the window with no other IED was shorten in this case, and therefore the data after 15s could be contaminated by other IEDs. It is remarkable that the HRs of epileptic spikes, events that last 100 to 200ms, seem to last over 30 seconds, in one patient up to 45 seconds. The variability in observed response from patient to patient could reflect normal inter-subject variability (Aguirre et al 1998) or variable types of epileptic processes. In order to evaluate this possibility, it will be necessary to study many patients with different pathologies. The variability in HR morphology contrasts with a remarkable intra-patient similarity in the mean HRs across areas, in those patients with more than one active area.

The variability in the amount of signal change across patients could be due to different densities of active neurons. It could be also that in some cases the EEG spike simply results from

a neuronal synchronization in a region that is also active away from spikes, but less synchronized: in this context, the synchronization would probably not imply a much higher metabolic demand. A third possibility is that different lesions may produce different patterns of activation - it is a point to be noted especially because the blood supply of some lesions may be abnormal.

In patient B, we noticed that for some events there is a BOLD response in the posterior temporal lobe and not in the anterior part, but not the reverse. This suggests that the posterior region may be a 'primary' region and the anterior a place of non-systematic propagation. This is compatible with EEG interictal and ictal findings in this patient. Indeed, the coherence function (Gotman 1983) computed on 4 epochs of bursts between bipolar EEG channels T3-T5 (posterior) and Fp1-F7 (anterior) shows a slope of -3.6 deg/Hz, which corresponds to a delay of 100ms, with the posterior region leading. Also, on ictal EEG, the activity seems to start at the posterior temporal electrode (T3) and propagate to other regions, including anteriorly (F7).

The statistical method used to analyze the relationships between epileptic events and BOLD response is derived from the methods used for classical event-related behavioral studies. Some of our findings raise the possibility that this may not be the optimum approach. Three factors are particularly worth noticing. (1) Some transient BOLD signal increase away from IEDs resemble the HR and could correspond to deep epileptic discharges that are not visible on scalp EEG. The time course model can obviously not take into account such events. (2) We have seen that the HR shape may differ significantly from the standard model. (3) Epileptic events are variable in intensity and result in variable amplitude single BOLD responses. All these factors could be taken into account in the statistical analysis and would probably result in better detection power. Indeed, we repeated the statistical processing for patient A with his average HR as a model, and found a maximum t-stat score of 13.1 instead of 7.6 with the Glover model. Another possibility would be to use methods that do not rely on a specific shape of response (Josephs et al. 1997).

We obtained statistically significant regions that correspond only to small areas of cortex. We know from previous studies that this is probably only the 'tip of the iceberg', as such areas are too small to produce a visible EEG deviation on the scalp (Cooper et al. 1964, Merlet and Gotman 1999). Improving the detection method as outlined above would probably increase the extent of significant areas, but one has to keep in mind that EEG and fMRI are measuring

different phenomena and that one cannot expect a one-to-one relationship between them (Nunez and Silberstein 2000).

Epileptic spikes are often considered an important marker of the epileptogenic region, but they are usually considered of no clinical significance in themselves. It has been demonstrated, however, that they can result in a brief cognitive impairment (Shewmon and Erwin 1988, Binnie and Marston 1992). We show here that in some patients each spike results in a clear hemodynamic response lasting 30 to 40 seconds, whereas in others the response is of much smaller amplitude and duration. This opens the door to a new differentiation between spikes possibly having different mechanisms and significance. We have also shown that the HR of epileptic spikes can be somewhat different from the standard model and different from patient to patient. This will result in more complex analysis procedures, since the standard model is not likely to be optimum.

ACKNOWLEDGEMENTS

This work was supported by the Canadian Institutes of Health Research (CIHR) under grant MOP-38079. C.G. Bénar is funded by a CIHR doctoral research award.

REFERENCES

Aguirre G.K., Zarahn E., D'Esposito M. 1998. The variability of human, BOLD hemodynamic responses. *Neuroimage* **8**(4):360-9.

Allen P.J., Polizzi G., Krakow K., Fish D.R., Lemieux L. 1998. Identification of EEG events in the MR scanner: the problem of pulse artifact and a method for its subtraction. *Neuroimage* **8**(3):229-39.

Baudewig J., Bittermann H.J., Paulus W., Frahm J. 2001. Simultaneous EEG and functional MRI of epileptic activity: a case report. *Clin. Neurophysiol.* **112**(7):1196-200.

Binnie C.D., Marston D. 1992. Cognitive correlates of interictal discharges. *Epilepsia* **33** Suppl 6:S11-S17.

Buxton R.B., Wong E.C., Frank L.R. 1998. Dynamics of blood flow and oxygenation changes during brain activation: the balloon model. *Magn. Res. Med.* **39**(6):855-64.

Cooper R., Winter A.L., Crow H.J., Walter W.G. 1965. Comparison of subcortical, cortical and scalp activity using chronically indwelling electrodes in man. *Electroenceph. Clin. Neurophysiol.* **18**:217-228

Glover G.H. 1999. Deconvolution of impulse response in event-related BOLD fMRI. *Neuroimage* **9**(4):416-29.

Gotman J. 1983. Measurement of small time differences between EEG channels: method and application to epileptic seizure propagation. *Electroenceph. Clin. Neurophysiol.* **56**(5):501-14.

Hoffmann A., Jager L., Werhahn K.J., Jaschke M., Noachtar S., Reiser M. 2000. Electroencephalography during functional echo-planar imaging: detection of epileptic spikes using post-processing methods. *Magn. Reson. Med.* **44**(5):791-8.

Hoge R.D., Atkinson J., Gill B., Crelier G.R., Marrett S., Pike G.B. 1999. Investigation of BOLD signal dependence on cerebral blood flow and oxygen consumption: the deoxyhemoglobin dilution model. *Magn. Reson. Med.* **42**(5):849-63.

- Huang-Hellinger F.R., Breiter H.C., McCormack G, Cohen M.S., Kwong K.K., Sutton J.P., Savoy R.L., Weisskoff R.M., Davis T.L., Baker J.R., Belliveau J.W., Rosen B.R. 1995. Simultaneous functional magnetic resonance imaging and electrophysiological recording, *Hum. Brain Map.* **3**:13-23
- Ives J.R., Warach S., Schmitt F, Edelman R.R., Schomer D.L. 1993. Monitoring the patient's EEG during echo planar MRI. *Electroenceph. Clin. Neurophysiol.* **87**(6):417-20.
- Josephs O., Rees G., Turner R., Friston K. J. 1997. Event-related fMRI. *Hum. Brain Map.* **5**:243-248
- Krugel F., von Cramon D.Y., Descombes X. 1999. Comparison of filtering methods for fMRI datasets. *Neuroimage* **10**(5):530-43.
- Kwong K.K., Belliveau J.W., Chesler D.A., Goldberg I.E., Weisskoff R.M. 1992. Dynamic magnetic resonance imaging of human brain activity during primary sensory stimulation. *Proc. Natl. Acad. Sci. USA* **89**:5675-79
- Lemieux L., Salek-Haddadi A., Josephs O., Allen P., Toms N., Scott C., Krakow K., Turner R., Fish D.R. 2001. Event-Related fMRI with Simultaneous and Continuous EEG: Description of the Method and Initial Case Report. *Neuroimage* **14**(3):780-7.
- Merlet I., Gotman J. 1999. Reliability of dipole models of epileptic spikes. *Clin. Neurophysiol.* **110**(6):1013-28.
- Nunez P.L., Silberstein R.B. 2000. On the relationship of synaptic activity to macroscopic measurements: does co-registration of EEG with fMRI make sense? *Brain Topogr.* **13**(2):79-96.
- Ogawa S., Tank D.W., Menon R., Ellermann J.M., Kim S.-G. 1992. Intrinsic signal changes accompanying sensory stimulation: functional brain mapping with magnetic resonance imaging. *Proc. Natl. Acad. Sci. USA* **89**:5951-55
- Ogawa S., Menon R.S., Kim S.G., Ugurbil K. 1998. On the characteristics of functional magnetic resonance imaging of the brain. *Annu. Rev. Biophys. Biomol. Struct.* **27**:447-74.

Seeck M., Lazeyras F., Michel C.M., Blanke O, Gericke C.A., Ives J., Delavelle J., Golay X., Haenggeli C.A., de Tribolet N., Landis T. 1998. Non-invasive epileptic focus localization using EEG-triggered functional MRI and electromagnetic tomography. *Electroenceph. Clin. Neurophysiol.* **106**(6):508-12.

Shewmon D.A., Erwin R.J. 1988. The effect of focal interictal spikes on perception and reaction time. I. General considerations. *Electroenceph. Clin. Neurophysiol.* **69**(4):319-37.

Warach S., Ives J.R., Schlaug G., Patel M.R., Darby D.G., Thangaraj V, Edelman R.R., Schomer D.L. 1996. EEG-triggered echo-planar functional MRI in epilepsy. *Neurology* **47**(1):89-93.

Worsley K.J., Marrett S., Neelin P., Vandal A.C., Friston K.J., and Evans, A.C. 1996. A Unified Statistical Approach for Determining Significant Signals in Images of Cerebral Activation. *Hum. Brain Map.* **4**:58-73.

FIGURE CAPTIONS

Table 1: Comparison of EEG and fMRI findings

Figure 1: Schematic representation of the selection of the BOLD signal time point corresponding to the EEG event. Middle: relative time. Above the time line: two fMRI frames (consisting each of 25 slices; the slice containing the maximum of the ROI is raised). Below the time line: EEG event. Star: BOLD signal sample, circle: interpolated point. The origin of time is taken as the closest point to the EEG event.

Figure 2: Examples of IEDs recorded during scanning and subsequently filtered (gray boxes: time windows and channel used in computing the IED energy). Reference electrodes: $(F3+F4)/2$. Time lines are separated by 1s.

Figure 3: Functional MRI activations (t-stat thresholds: 3 for Patients A, B, C, 1.5 for patient D; the color range spans between the threshold and the maximum in the image). One slice each is shown for patients A, B and C. Patients A and B have only one region of activation. In patient C, both regions of activation are visible on the same slice. In patient D, the three regions of activation are shown on three different slices.

Figure 4: The BOLD signal in the ROI of one run for each patient. Arrows: epileptic discharges, star: event that correlate with the HR but not preceded by a scalp IED. Each point corresponds to one 3s frame. (a-d) Patients A-D

Figure 5: Average hemodynamic response and model (dotted lines); (a-d) Patients A-D. The model has been scaled in amplitude for each patient to enable direct comparison. Signals are presented in percent of activation relative to the baseline. For patient B, the model has been convolved with a 5s window to take into account the average burst duration.

Figure 6: Plots of root energy of the BOLD signal versus root energy of the EEG signal for the set of isolated IEDs.

Figure 7: Left column: three runs of patient B (black trace: posterior temporal ROI, gray trace: anterior temporal). Right column: corresponding correlation coefficient between the two areas with a 30s sliding window (arrows: epileptic discharges).

Plus sign: High correlation between BOLD signals in the absence of scalp IED; Star: low correlation between BOLD signals in the presence of scalp IED.

Patient	EEG activity	# runs	# IED's	# IED's in average HR	fMRI activation	Max. t-score	# significant voxels
A	L posterior temporal	8	7	6	L posterior temporal	7.6	20
B	L temporal	7	34	14	L posterior temporal L anterior temporal	14 8.1	32 58
C	R frontal	9	218	27	R superficial frontal	8.7	39
D	L temporal	10	98	9	L temporal L parieto-temporo-occipital L parietal	4.7 4.9 4.9	2 1 2

Table 1

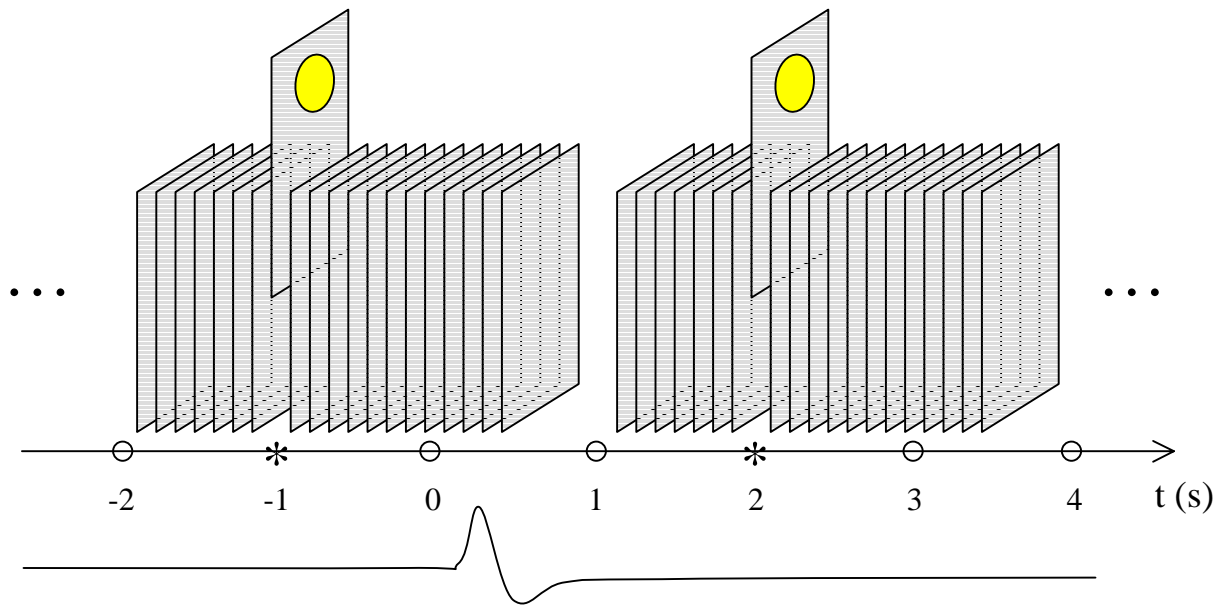

Figure 1

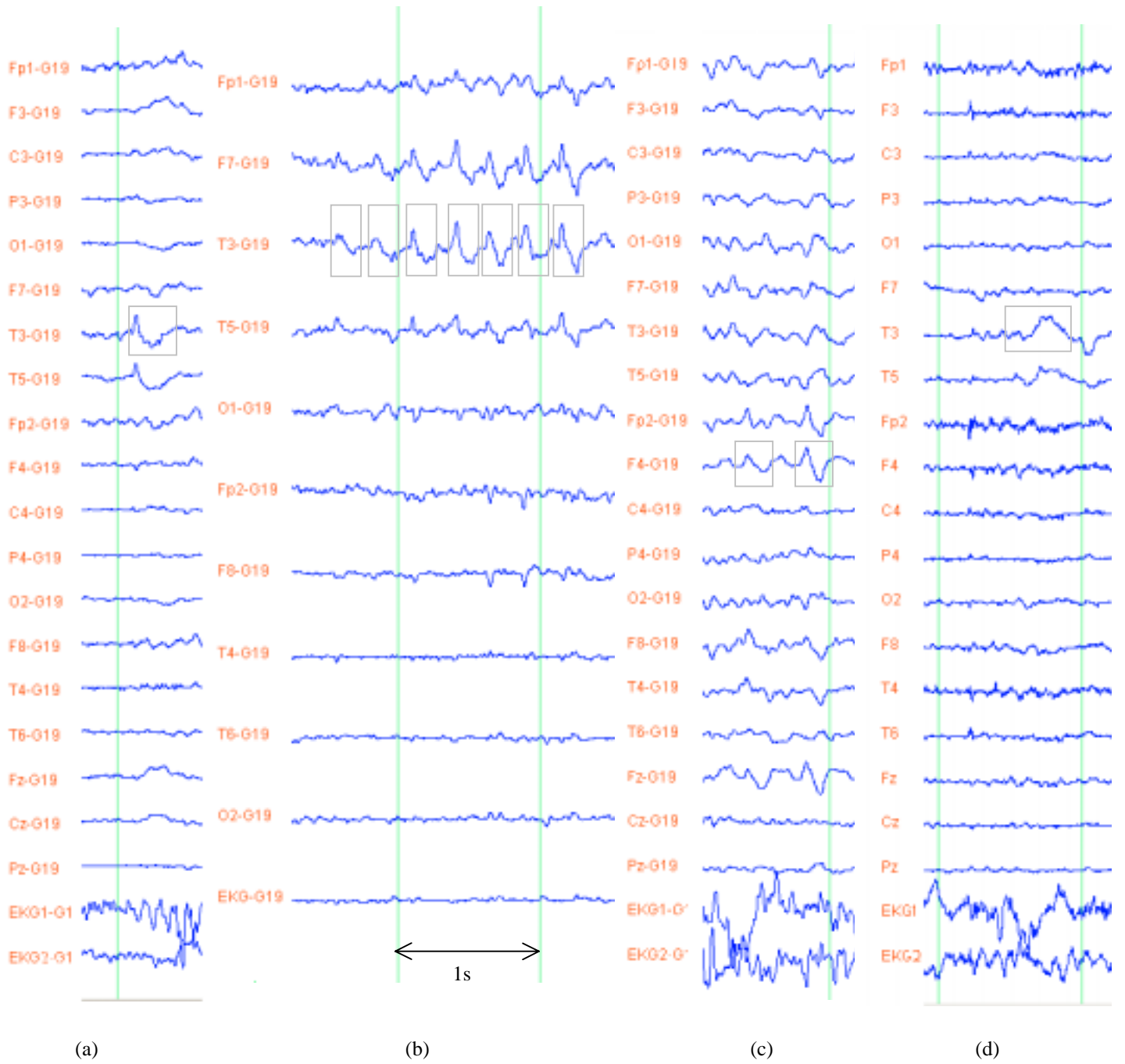

Figure 2

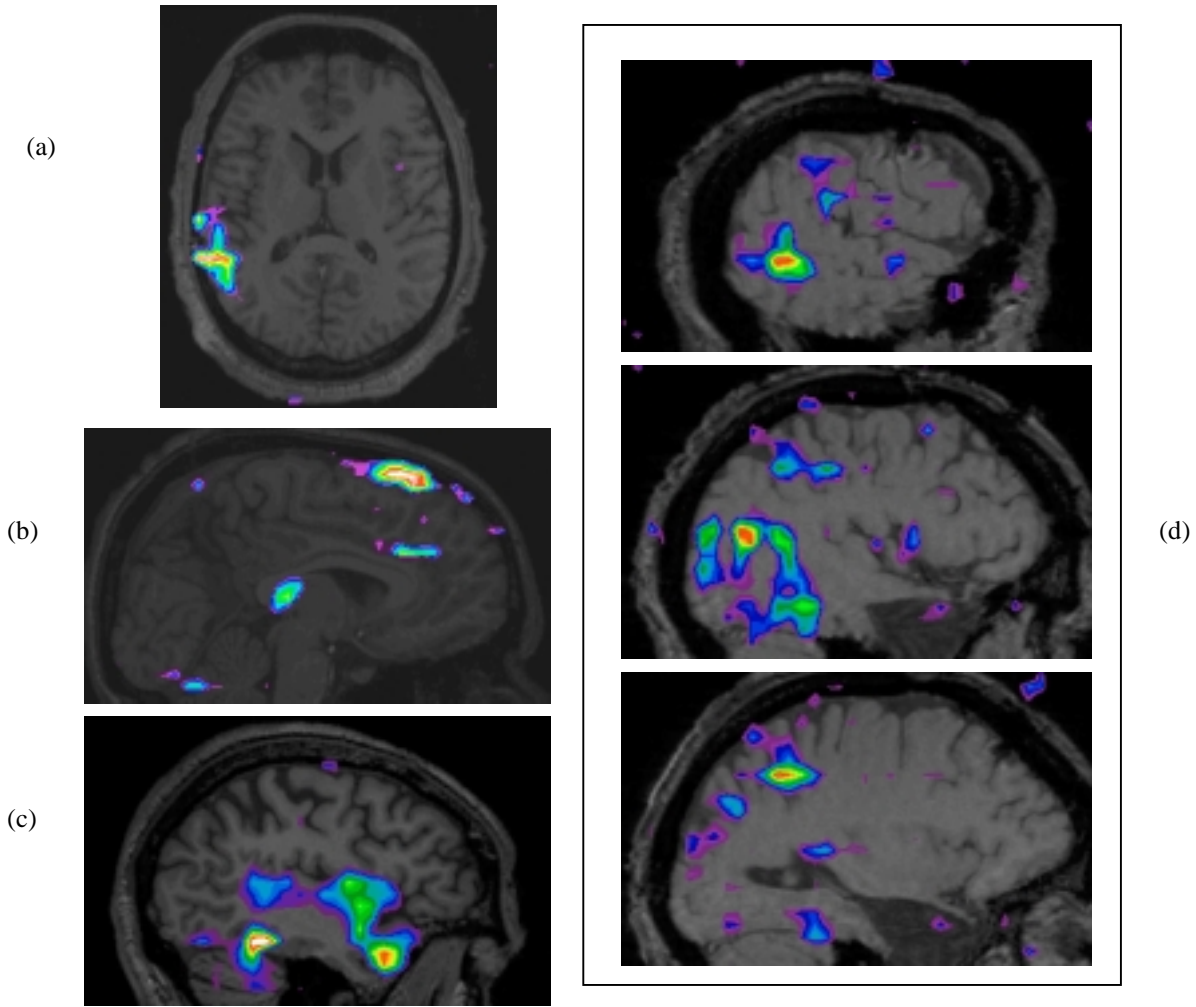

Figure 3

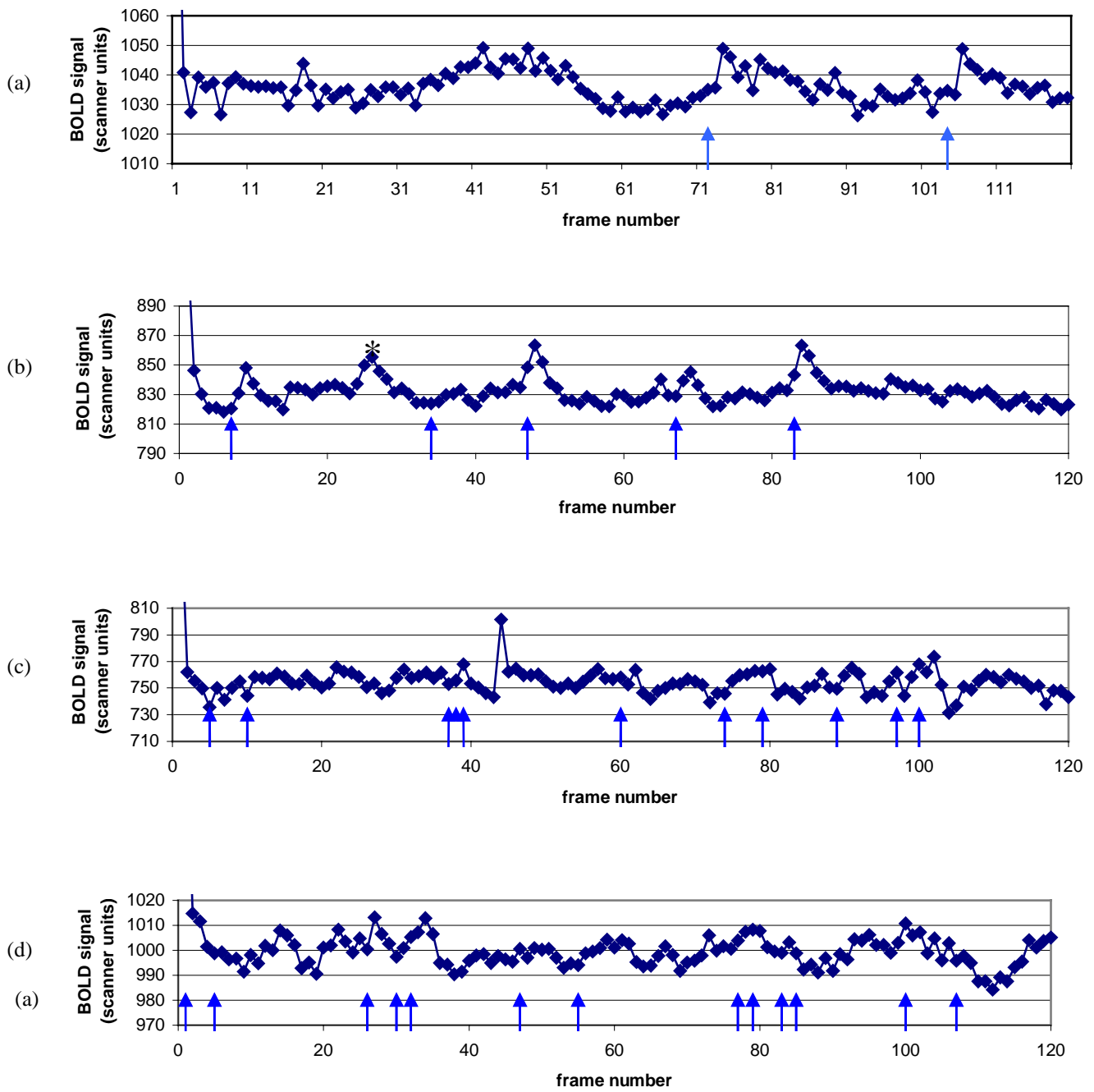
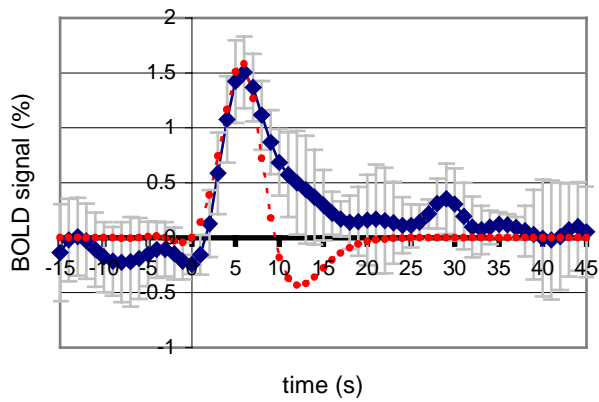
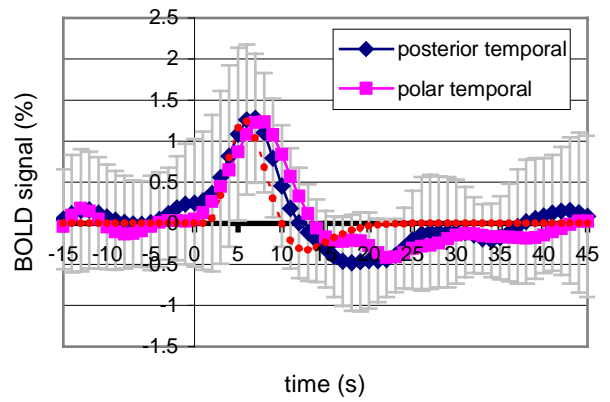

Figure 4



(a)



(b)

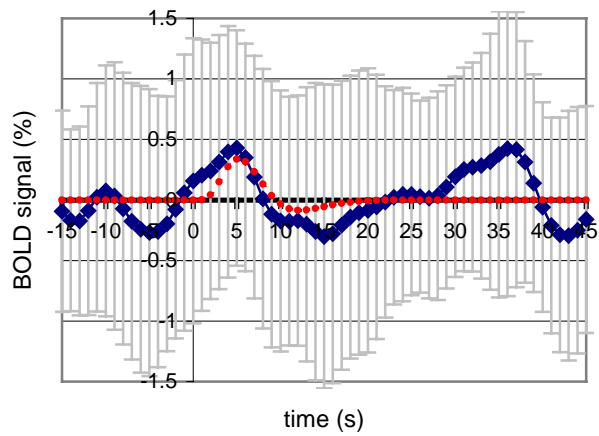

(c)

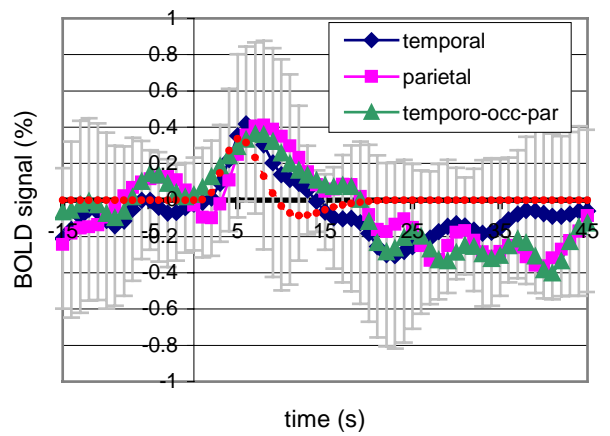

(d)

Figure 5

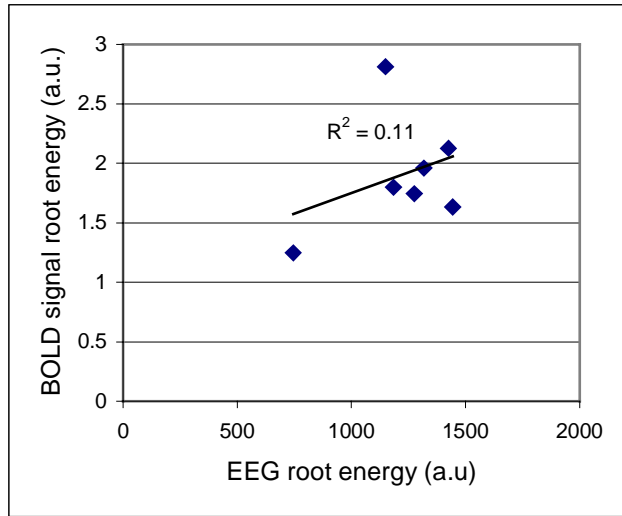

(a)

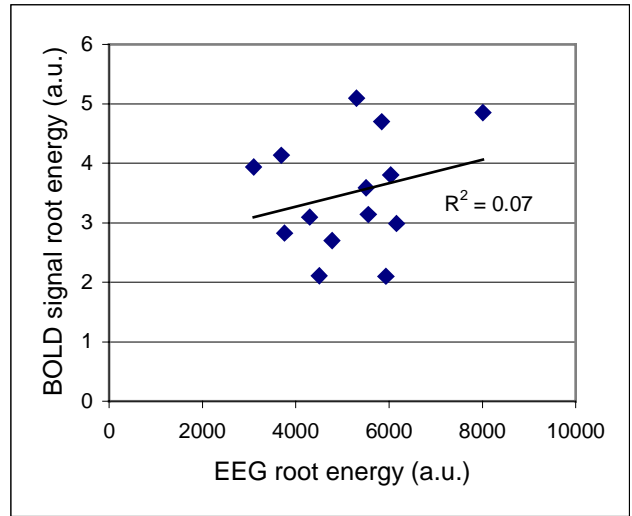

(b)

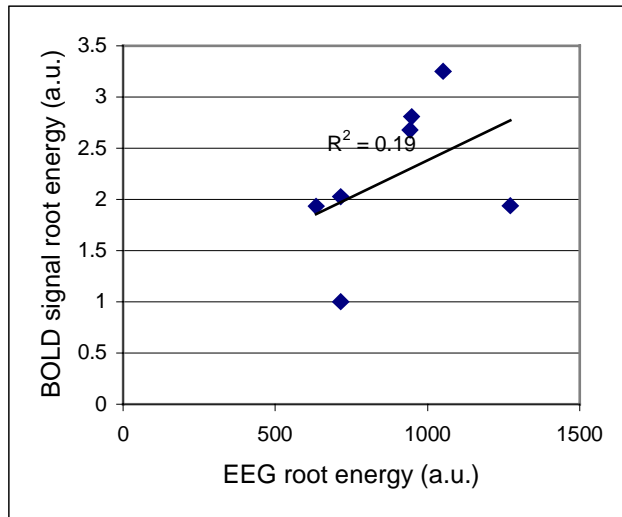

(c)

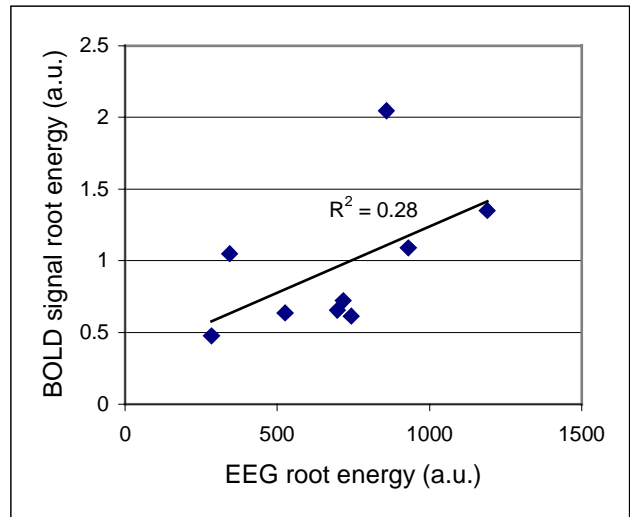

(d)

Figure 6

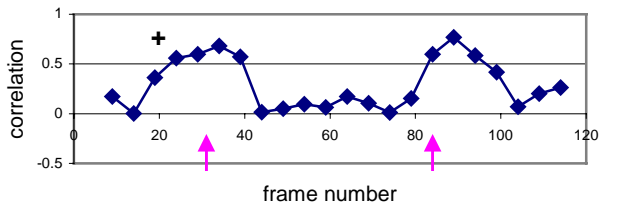
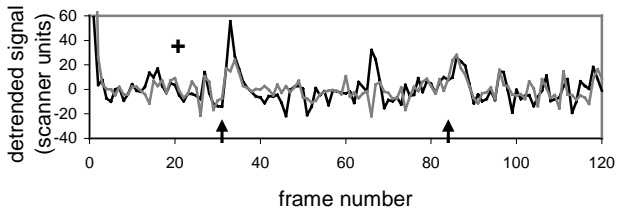
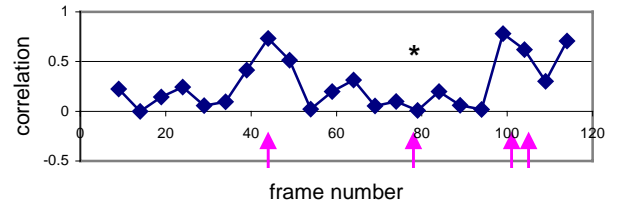
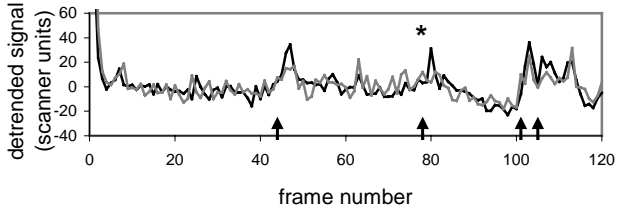
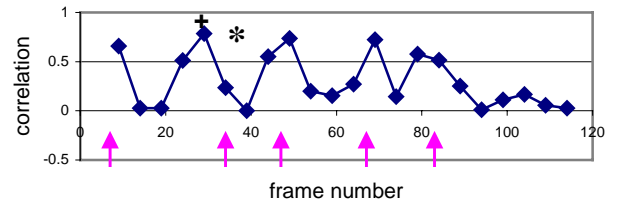
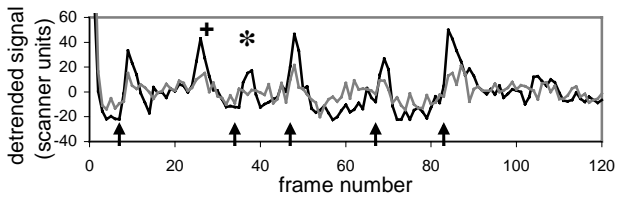

Figure 7